



GENUINE CAR-NAVIGATION UNIT

INSTALLATION INSTRUCTIONS

Thank you for purchasing a genuine Mazda accessory.
Before removal and installation, be sure to thoroughly read these instructions.
Please read the contents of this booklet in order to properly install and use the car-navigation unit. Your safety depends on it.
Keep these instructions with your vehicle records for future reference.

WARNING

- There are several  **WARNING** and  **CAUTION** sections in this booklet concerning safety when installing or removing the car-navigation unit. Always read and follow them in order to prevent injuries, accidents, and possible damage to the vehicle.

 **WARNING:** Indicates a situation in which serious injury or death could result if the warning is ignored.

 **CAUTION:** Indicates a situation in which bodily injury or damage to the vehicle could result if the caution is ignored.

- For areas indicating the tightening torque in this instruction manual, tighten to the specified torque using a torque wrench. For areas in which the tightening torque is indicated inside parentheses (), the tightening torque is indicated as a reference value, however tightening using a torque wrench is not necessary.
- Do not modify the car-navigation unit.
- Do not install the car-navigation unit in any way other than described in the following instructions.
- If in any doubt, please ask your Mazda dealer to install the accessory in order to prevent errors in installation.
- If you have any questions about the use of the accessory, ask your Mazda dealer for proper advice before using it.
- Mazda and its suppliers are not responsible for injuries, accidents, and damage to persons and property that arise from the failure of the dealer or installer to follow these instructions.
- To ensure safety and reliability of the work, installation, removal and disposal work must be carried out by an Authorized Mazda Dealership.
- Be careful not to lose removed parts, and be sure that they are kept free from scratches, grease or other dirt.

PART NAME: CAR-NAVIGATION UNIT
PART NUMBER: GJY1 79 EZX (US/CANADA)
GJY2 79 EZX (MEXICO)
VEHICLE: MAZDA6

NOTE

To the dealer

- Please turn over these instructions to the customer after installation.

To the customer

- Keep these instructions after installation. The instructions may be necessary for installing other optional parts or removal of this accessory.
- Should the vehicle or this accessory be resold, always leave these instructions with it for the next owner.

1. PARTS



NOTE: Requires factory installed 5.8" display. Not needed on vehicles with the Technology Package (they already have factory navigation). All parts are the same as OE (including SD card KD37-66-EZ1).

▼ PARTS LIST

NOTE:

- Before installation, verify that the kit includes all the following parts and that they are free of dirt, scratches, or damage.

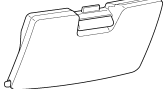
- GJY1 79 EZX (US/CANADA), GJY2 79 EZX (MEXICO)

Part	Part name	Qty.	Part	Part name	Qty.	Part	Part name	Qty.
	Car-navigation unit	1		Lid-NAVI	1		Installation instruction	1
	Owner's manual	1						

2. BEFORE INSTALLATION

▼ REQUIRED TOOLS

- ☆Phillips screwdriver
- ☆Torque wrench
- ☆Tape-wrapped flathead screwdriver
- ☆Socket wrench (10mm) or Spanner wrench (10mm)
- ☆Clean rag (soft cloth)

⚠ WARNING

- To prevent short related accidents while performing procedures, disconnect the negative battery cable before beginning any work.
- When disconnecting the connector, hold the connector itself to remove while pressing the connector lock.
- Do not apply excessive force to the wiring harness as it could cause an open circuit.
- When locking connectors, listen for a click that will indicate they are securely locked.
- Be careful not to pinch the wiring harness. Otherwise, the harness may be broken.

⚠ CAUTION

- When removing and installing vehicle parts, make sure they are clean with no scratches. Also, be sure to cover the vehicle body with protectors or mats when removing/installing parts to prevent scratches and dirt.

NOTE:

- Refer to the applicable Workshop Manual for removal and installation of vehicle parts. Not following the procedures for removal/installation in the Workshop Manual could result in an accident or vehicle malfunction.
- When the negative battery cable is removed, the clock, radio, trip meters and other memories will be erased. Before performing work, record the content of the memory.

3. VEHICLE PARTS REMOVAL

NOTE:

- The following vehicle parts removal procedure is for left-hand drive vehicles. Perform the same procedure for right-hand drive vehicles.

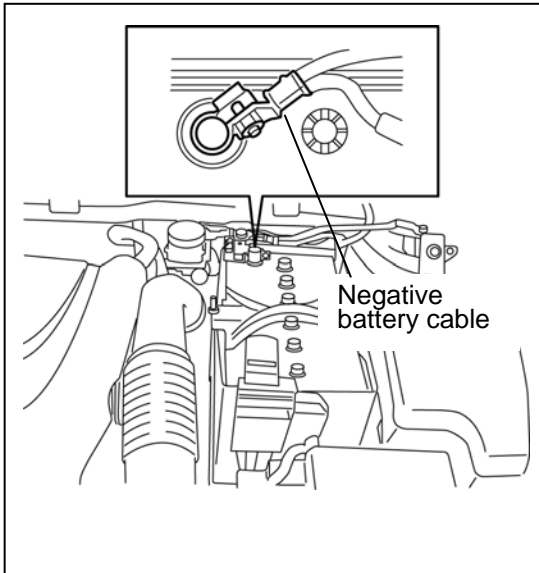

Negative battery cable disconnection

1. Set the selector lever to P range.
(AT vehicles only)

⚠ WARNING

- When removing/installing the parts, park the vehicle on level ground and apply the side brake securely. Be sure to turn the ignition switch off, otherwise the vehicle can move, causing personal injury or vehicle damage.

2. Disconnect the negative battery cable and wrap tape around it to insulate.

⚠ WARNING

- When the negative battery cable is connected during operation, it may cause electric shock or other personal injuries. Disconnect the negative battery cable before removal/installation.

4. INSTALLATION

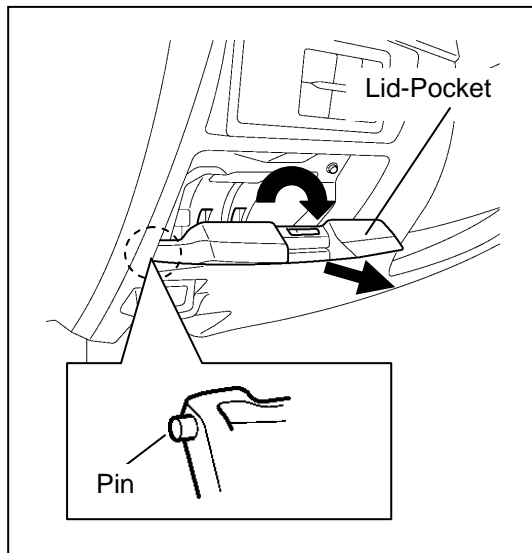

CAR-NAVIGATION UNIT INSTALLATION

Pocket Assy Removal

1. Open the lid-pocket, remove the pins (1 each, left and right) from the underside of the lid-pocket, and remove the lid.

- Dispose of the removed lid-pocket.

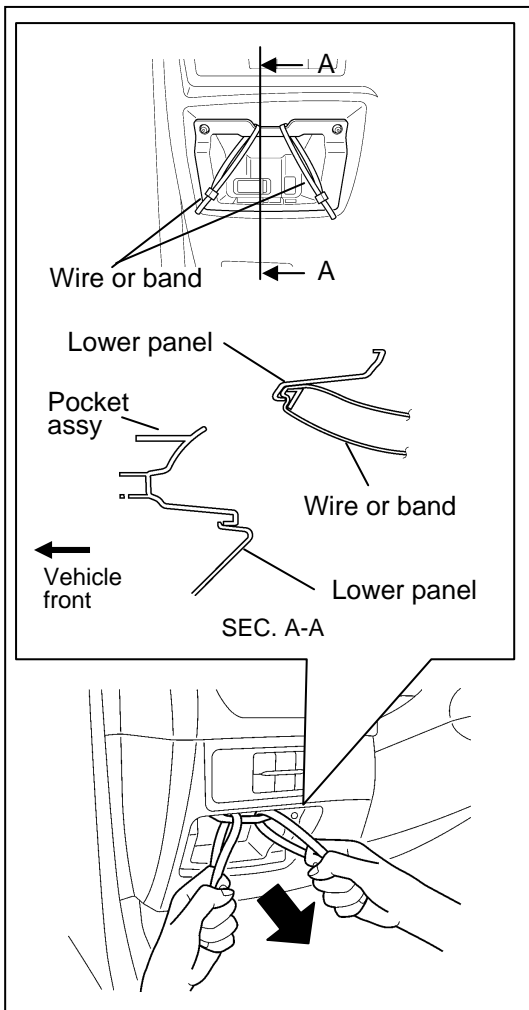

2. Insert two pieces of wire or two bands (use hard acrylic bands) into the locations shown in the figure and secure both ends. (Figure shows bands being used)
3. Pull the wires or bands in the direction shown in the figure and pull out the pocket assy.

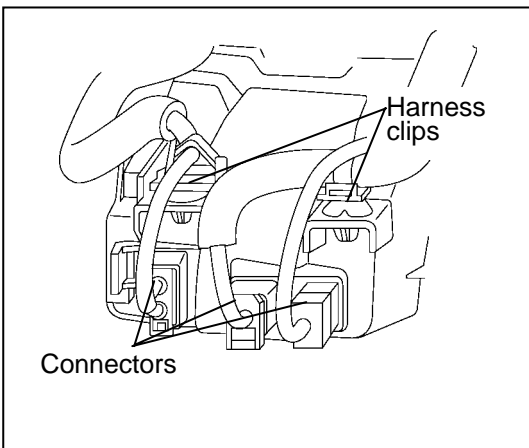

4. Remove the wiring harness clips (2) on the back of the pocket assy.

- Be careful not to apply excessive force to the wiring harness when removing the connectors.

5. Disconnect the connectors (3).

- Reuse harness clips(2).
- Dispose of the removed pocket assy.

Car-navigation unit Installation

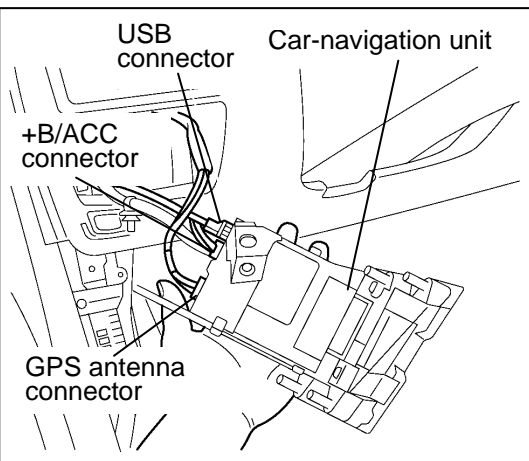

1. Connect the USB, GPS antenna, and +B/ACC connectors to the car-navigation unit.

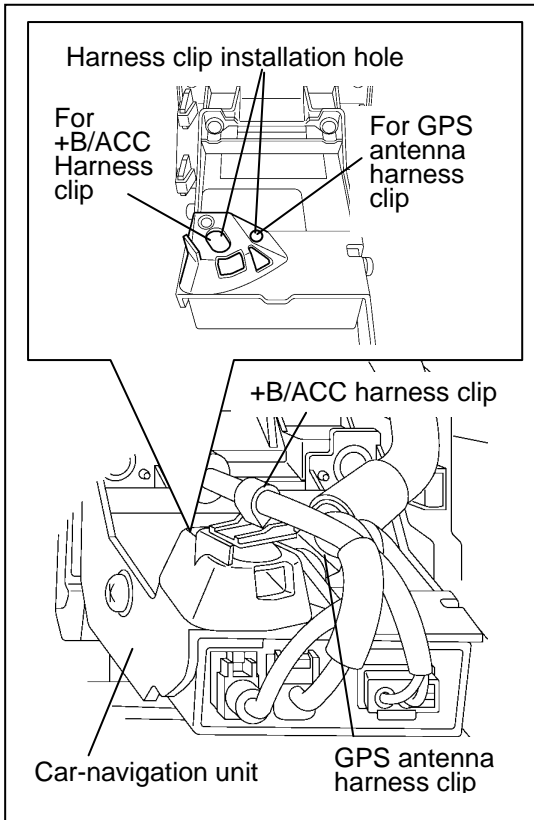

2. Install the wiring harness clips(2).

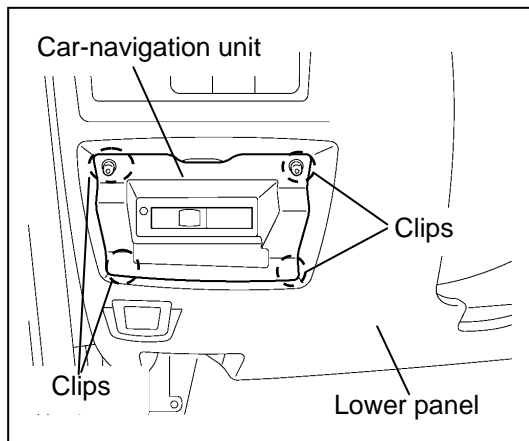

3. Press the clips (4 locations) shown in the figure and install the car-navigation unit to the lower panel.

⚠ CAUTION

- Be careful not to press the car-navigation unit when installing it.

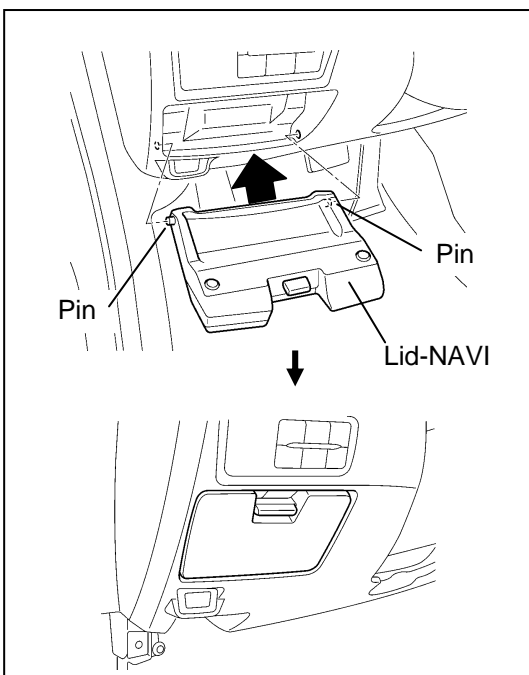

4. Install the lid-NAVI included in the kit.

GPS CONNECTOR INSTALLATION (US/CANADA only)

Glove compartment removal

1. Push the glove compartment in the direction of the arrow (1) and hooks A.
2. Pull the stay damper in the direction of the arrow (2) shown in the figure and remove the hook B.

⚠ CAUTION

- If the glove compartment is closed without being joined to the stay damper, the stay damper may be damaged. Verify that the stay damper is joined to the glove compartment before closing the glove compartment.

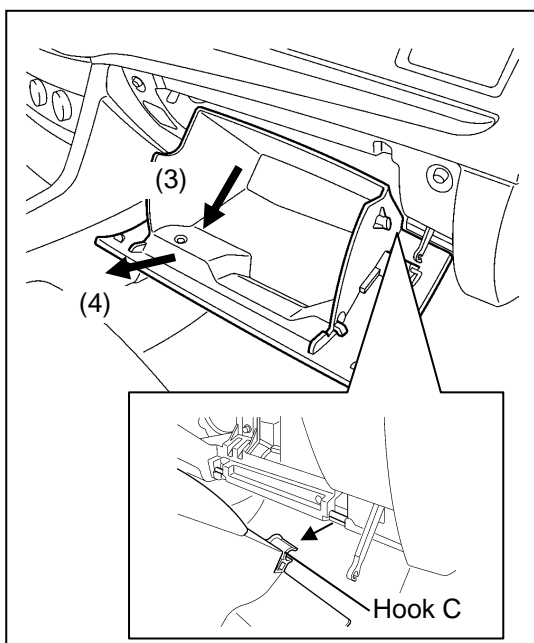
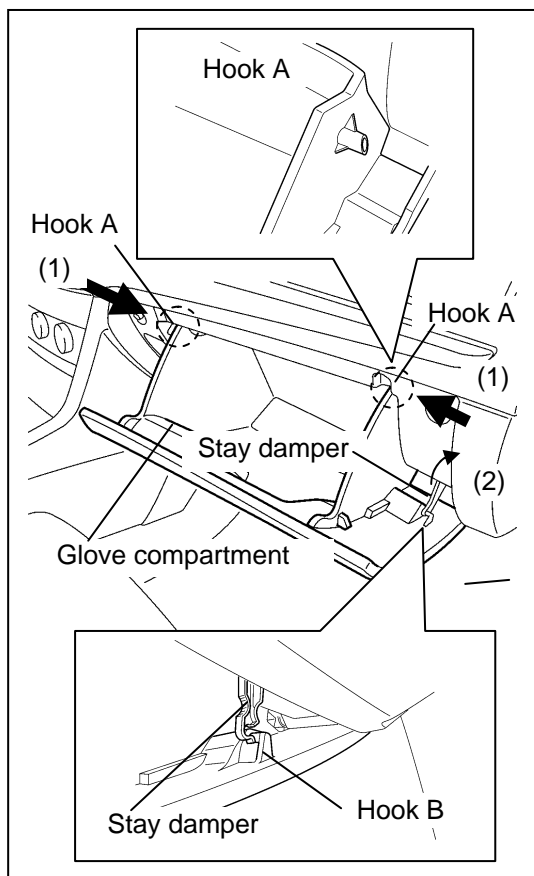

3. Pull down the glove compartment in the direction of the arrow (3).
4. Pull the glove compartment in the direction of the arrow (4) and remove it while detaching hooks C.

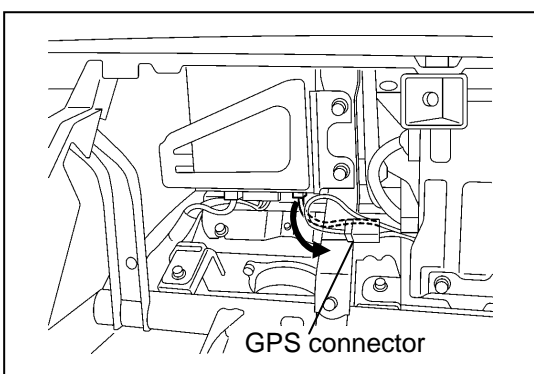

GPS connector installation

1. Disconnect the connector from the unit and connect it to the connector shown in the figure.
2. Install the glove compartment in the reverse order of removal.

5. OPERATION CHECK

1. Connect the negative battery cable and perform an operation check by referring to the owner's manual applicable to the vehicle.
2. If there is any malfunction, disconnect the negative battery cable and verify that each connector is properly connected and the wiring harnesses are not damaged or pinched, then perform the operation check again. If it does not operate normally, contact the dealer where the unit was purchased.
 - After installing the car-navigation unit, verify the connections of the GPS antenna, +B/ACC, and USB connectors using the following procedure:

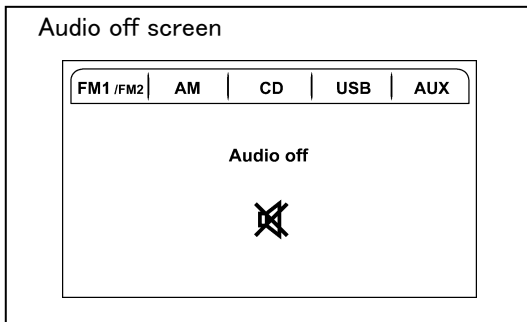

Connection verification of GPS antenna connector

1. Turn the ignition switch to the ON position.
 2. After the opening screen ends, the Audio off screen is displayed.
3. Press the POWER/VOLUME dial to switch to the on screen.

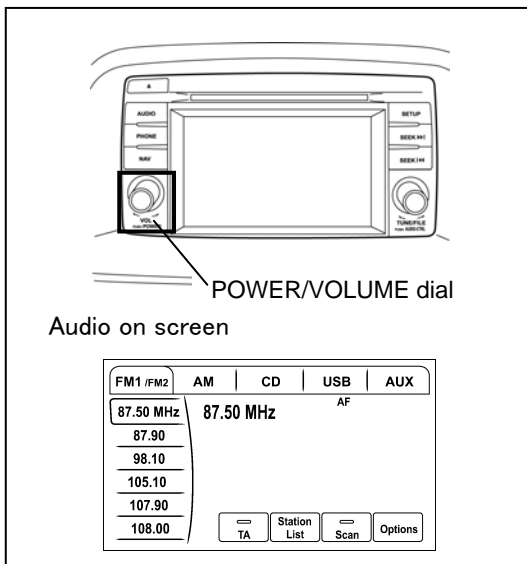

4. Press the POWER/VOLUME dial and SEEK UP button at the same time on the Audio on screen (press POWER/VOLUME dial a little earlier).

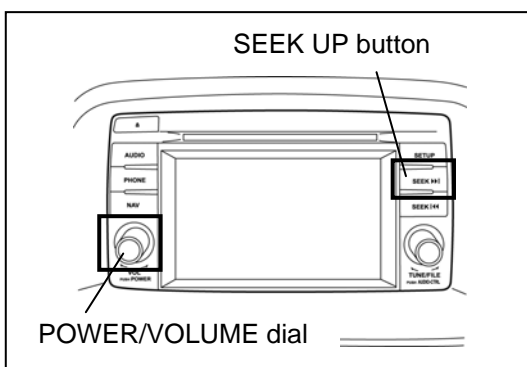

5. After switching to the AUDIO system screen, touch the buttons in the order of "1", "5" and "ENTER" on the screen.

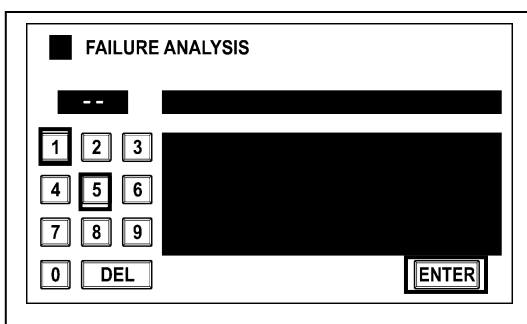

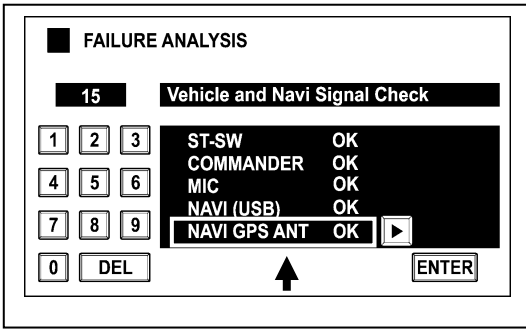

6. After switching to the Vehicle and Navi Signal Check screen, touch "▶" on the screen to switch the display screen to "NAVI GPS ANT". Verify that "NAVI GPS ANT: OK" is displayed. If not OK, verify the connection condition again.
7. Press the POWER/VOLUME dial to switch to the AUDIO screen.
8. Switch the ignition off

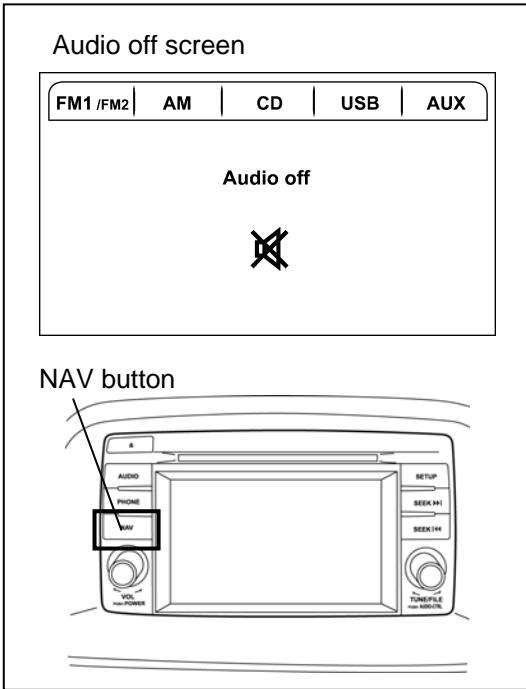

Connection verification of +B/ACC connector and USB connector

1. Turn the ignition switch to the ON position.
2. When the Audio off screen is displayed after the opening screen ends, press the NAV button.

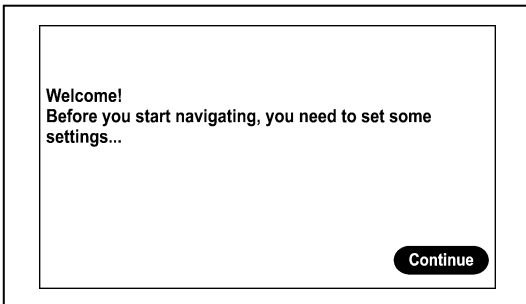

3. When the screen in the figure on the left is displayed, the connection verification is completed. If it is not displayed, verify the connection condition again.

- The procedure from this screen is performed by a user. This procedure ends on this screen.
- If the continue button is pressed, perform the "Reset procedure (Pg.9)".

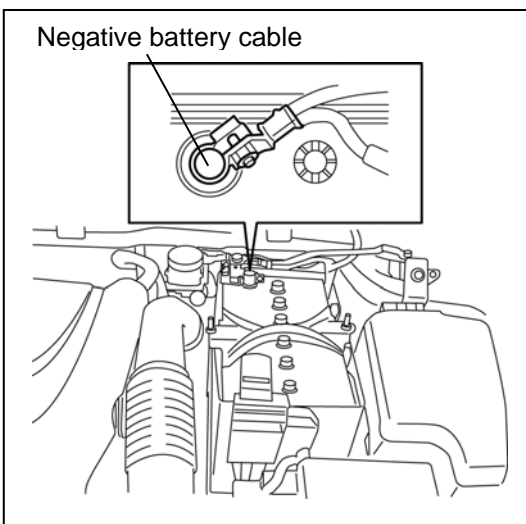

4. Switch the ignition off.
5. Connect the negative battery cable.

Tightening torque: 4.0–6.0 N·m

- Refer to "Required servicing after disconnecting/connecting negative battery cable" in the vehicle workshop manual or the owner's manual to restore the vehicle functions.

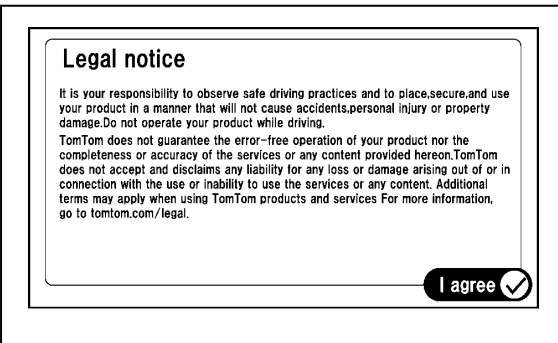
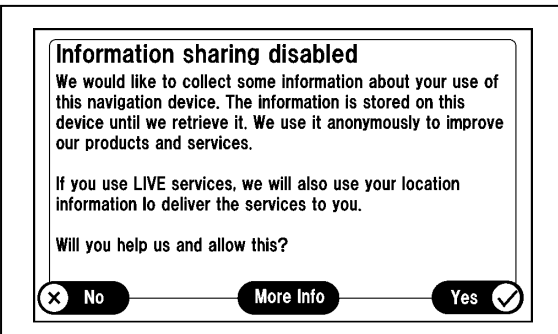
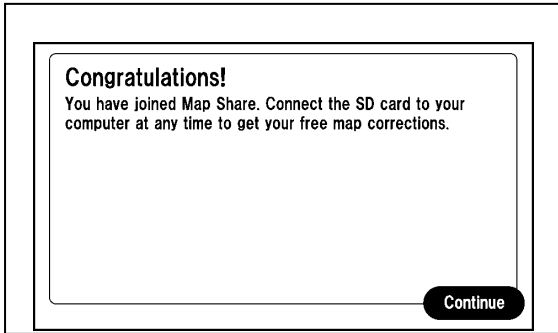
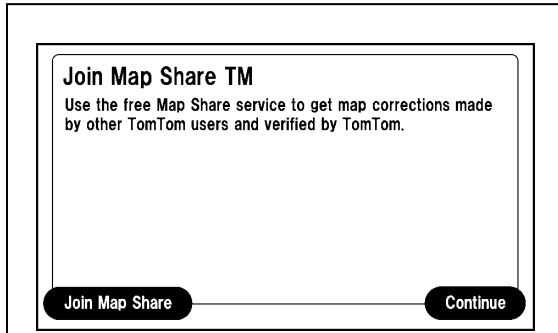
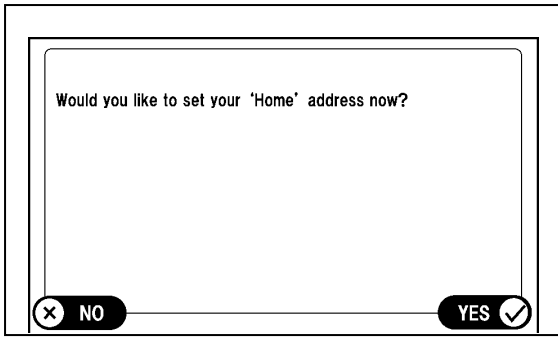

Reset procedure

- This procedure is in Step 3 of, "Connection verification of +B/ACC connector and USB connector (Pg. 8)", and is implemented only if the "Continue" button is pressed by mistake and the screen advances too far.

1. Touch "No".
2. Touch "Join Map Share".
3. Touch "Continue".
4. Touch "Yes".
5. Touch "I agree".

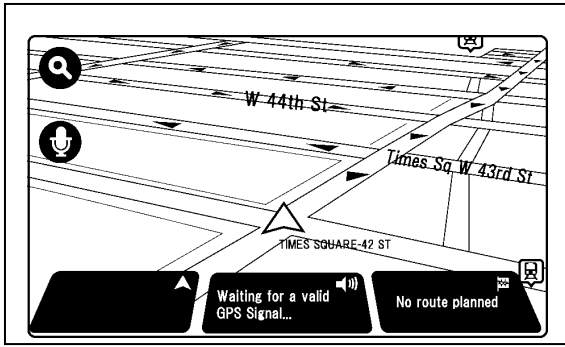

6. Touch the screen.

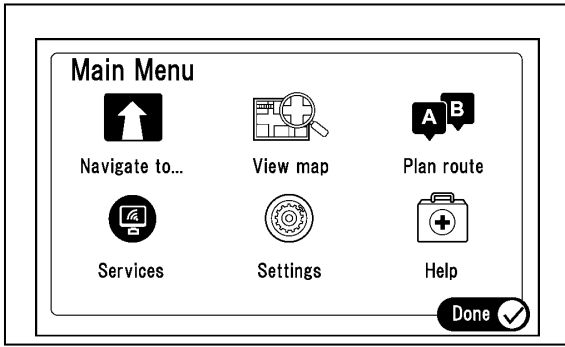

7. Touch "Setting".

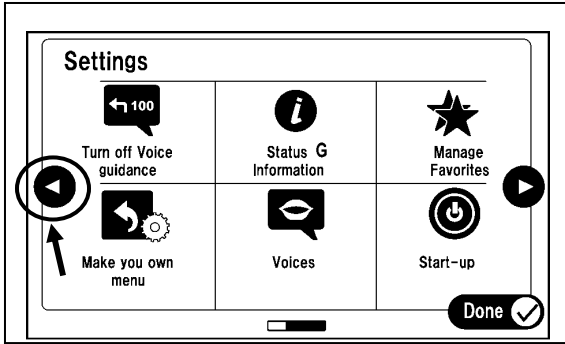

8. Touch the location shown in the figure.

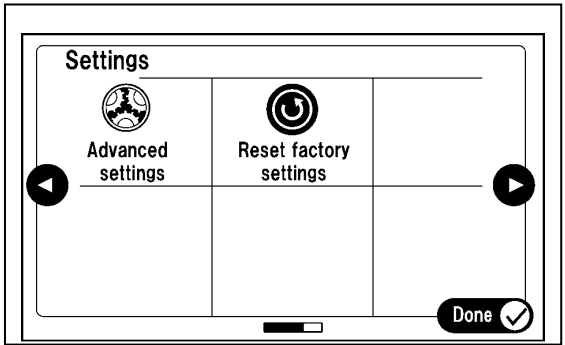

9. Touch "Reset factory setting".

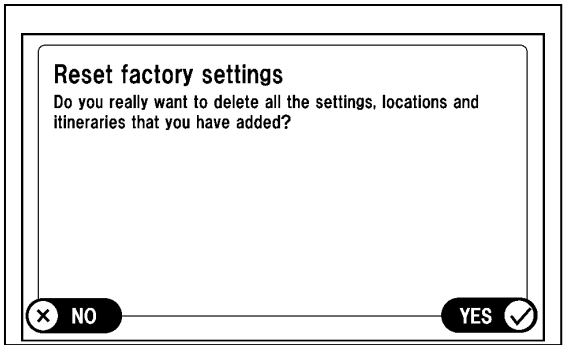

10. Touch "Yes".

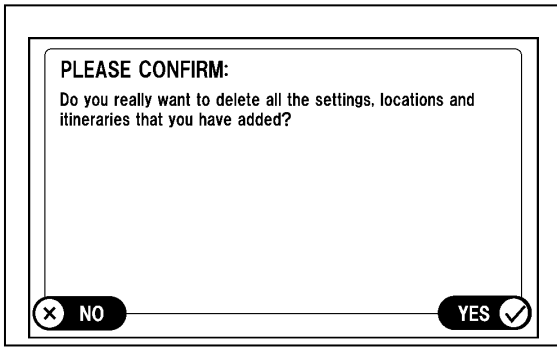

11. Touch "Yes".

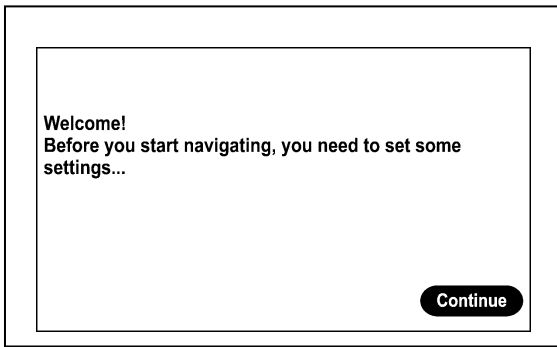

12. Setting is finished when "Welcome" screen appears.

13. Switch the ignition off.

Date				
VIN				
Approved		Checked		Person in charge

INSTALLATION INSPECTION SHEET	MAZDA6	Car-navigation unit
		GJY1 79 EZX (US/CANADA) GJY2 79 EZX (MEXICO)

Perform the following inspections

1. Inspection items after installation

Check

- Verify the fitting between the vehicle part and the installed part, and inspect for damage or dirt.

Check

- When connecting connectors, verify the connection again to prevent poor connection or mis-connection. (Insert two times.)

2. Vehicle parts reinstallation

Inspected part	Inspection item	Inspection	Check
Negative battery terminal	Torque change	Is the nut for the negative battery terminal tightened to the specified torque?	
Function restore procedure after removal/installation of battery	Operation	Have the vehicle's functions been restored by referring to "Required servicing after disconnecting/connecting negative battery cable", in the vehicle workshop manual or the owner's manual?	

3. Installation of accessory, operation check

Inspected part	Inspection item	Inspection	Check
Car-navigation unit	Check	Was "5. Operation check" performed?	